

	W
(A)	1560
(B)	1580
(C)	1600
(D)	1620
(E)	1640

- (A) :36
- (B) :46
- (C) :56
- (D) :66
- (E) :76

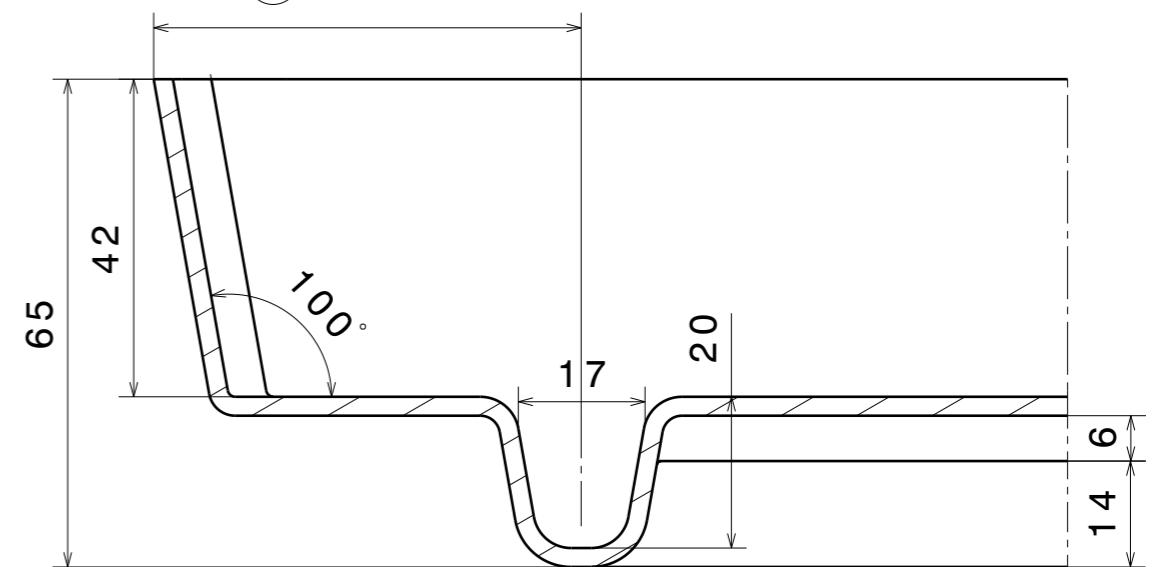

Section view A-A

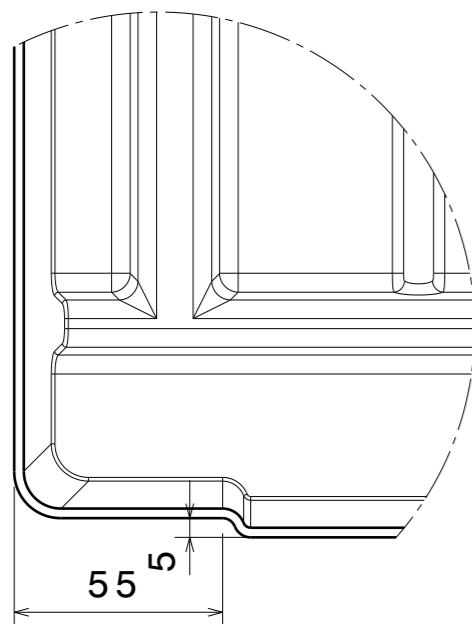

Detail B

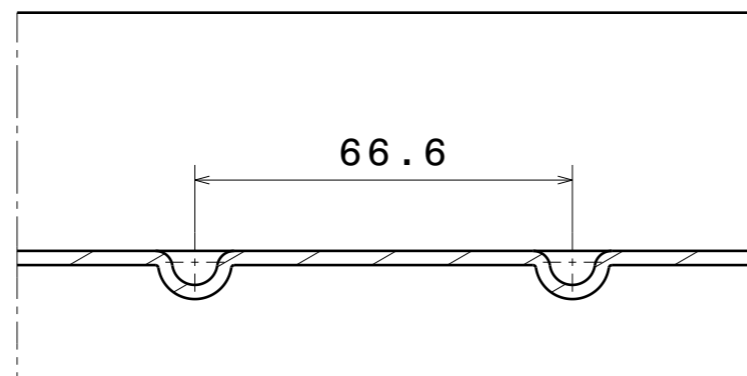

Section view C-C

TYPE 1600/9
End-tray with sump

Drawn by: JS
Date: 27.11.2013



Industrivej 19
DK-5750 Ringe - Denmark
Tel: +45 62621216 Fax +45 62623611
Web: www.staal-plast.dk
E-mail: mail@staal-plast.dk