

SECTION D-D

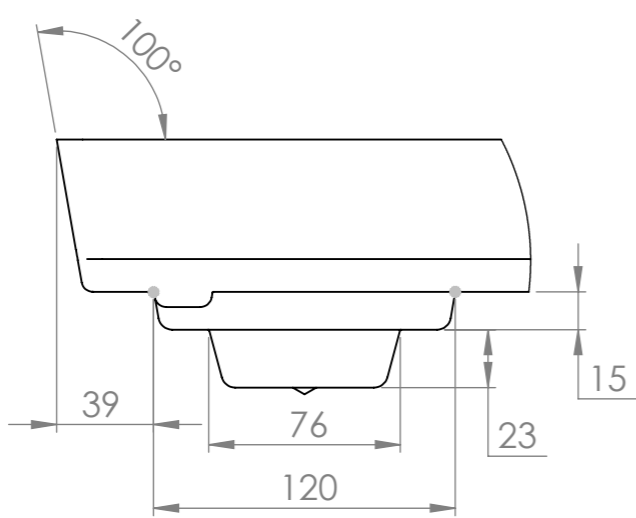

DETAIL F

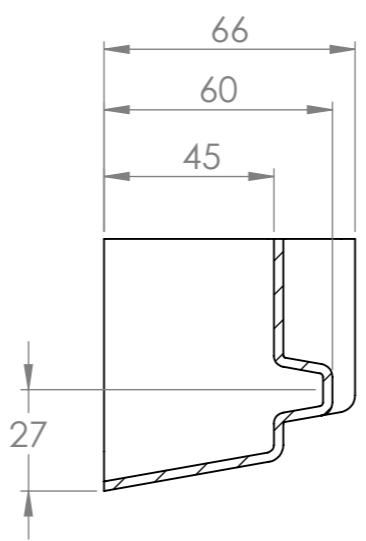

SECTION E-E

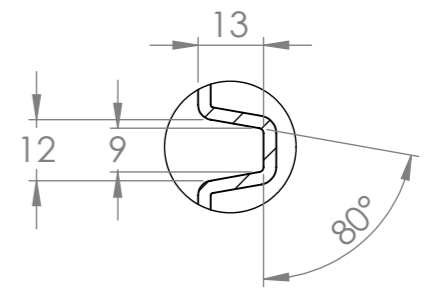

DETAIL G

Type 840/12		Drawn by: PBB
End-tray with sump		Date: 21.12.23
Tolerances at 20°C: 0000 - 1000 mm: ± 3,00 mm 1000 - 2000 mm: ± 3,50 mm		 Industrivej 19, 5750 Ringe - Denmark Telefon: +45 62621216 www.staal-plast.dk E-Mail: mail@staal-plast.dk